

Serie 1000 Premium Kraftsensor für die Prüftechnik [Premium Low-Profile® Load Cell]

- Dauerschwingfester Kraftaufnehmer
[Fatigue Rated Load Cell]
- 100 000 000 garantierte Voll-Lastwechsel Zug & Druck
[100 000 000 fully reversed cycles]
- Messbereiche von $\pm 1,25$ bis ± 4500 kN
[ranges from $\pm 1,25$ to ± 4500 kN]
- Kompensation der exzentrischen Kräfte
[eccentric load compensated]



Beschreibung [description]

Basierend auf dem Shear Web- oder Schubspannungsmessprinzip, bietet die robuste Serie 1000 eine hohe Steifigkeit (geringer Messweg) und Eigenfrequenz für die dynamische Verwendung. Die rotationssymmetrischen, niedrig bauenden Flachprofilkraftaufnehmer überzeugen durch ihre vielseitige Einsetzbarkeit mit Anwendungsschwerpunkt in Prüfständen z. B. in Automobil- und Flugzeugindustrie. Durch ein spezielles mechanisches Abgleichverfahren wird ein Übersprechen parasitärer Belastungen minimiert.

[Based on the shear web principle the robust 1000 series offers a high stiffness (low deflection) and high natural frequency which allows to use the sensor in dynamic applications. The Low Profile® sensors are rotationally symmetrical, flat and convince by their versatility with a focus on applications in testing technology, i.e. automotive and aerospace industry. Through a special mechanical adjustment process the 1000 series are insensitive to parasitic loads.]

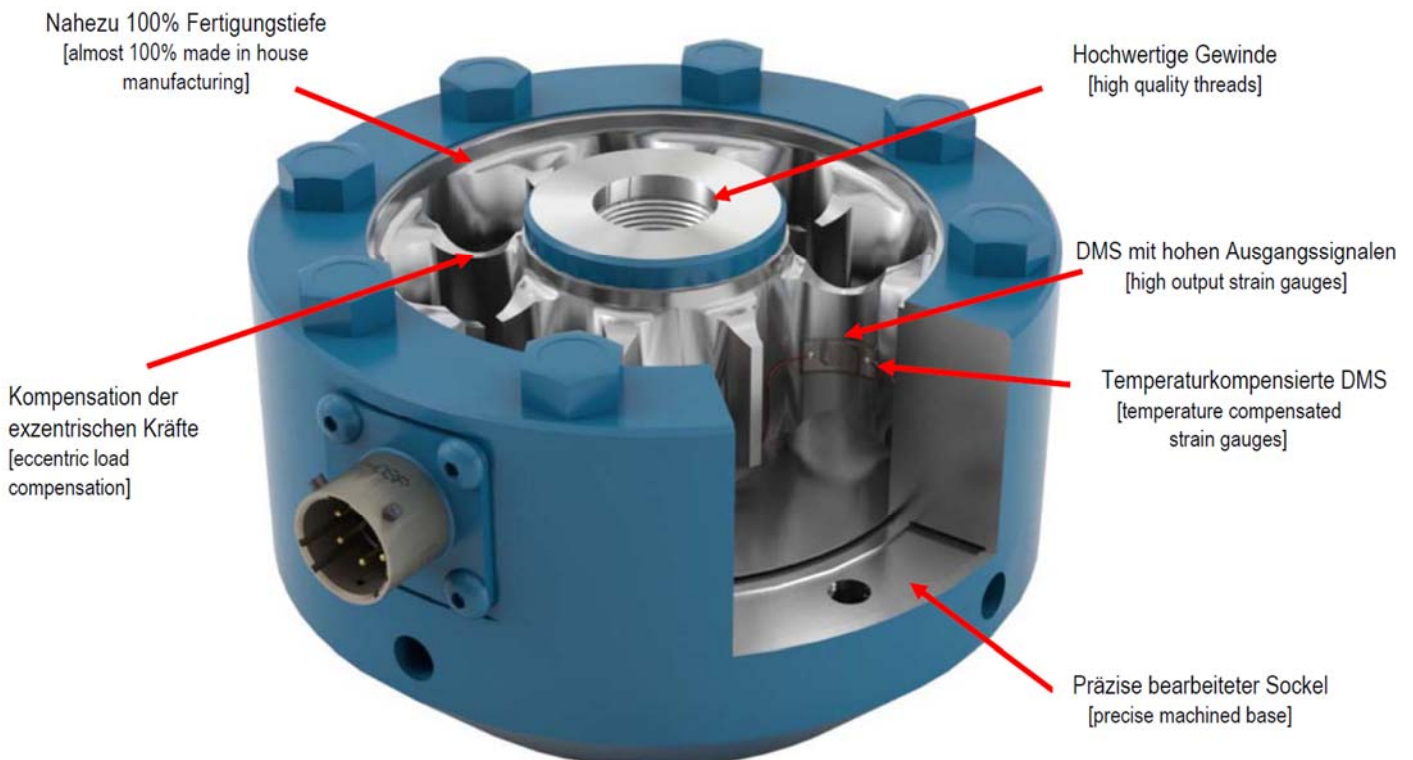

Technische Daten [technical data]

PARAMETER	MODELL [model]			
	1010	1010	1020	1032
	Nennkraft F _{nom} [range]			
U.S. lbf	250, 500, 1k	2.5k, 5k	12.5k, 25k	50k
Metrisch [metric] kN	1.25, 2.5, 5	12.5, 25	50, 125	225
GENAUIGKEIT – MAX FEHLER [accuracy – max error]				
Fehlerbandbreite – % Nennkraft F _{nom} [static error - %FS]	±0.03	±0.04	±0.04	±0.05
Rel. Linearitätsabweichung d _{lin} – % [nonlinearity - %FS]	±0.04	±0.04	±0.04	±0.05
Rel. Umkehrspanne u _{0,4} – % Nennkraft F _{nom} [hysteresis - %FS]	±0.03	±0.04	±0.05	±0.05
Rel. Reproduzierbarkeit – % [non-repeatability - %RO]	±0.02	±0.02	±0.02	±0.02
Rel. Kriechen, in 20 min – % [creep, in 20 min - %]	±0.025	±0.025	±0.025	±0.025
Seitenlastempfindlichkeit – % [side load sensitivity - %]	±0.1	±0.1	±0.1	±0.1
Fehler bei exzentr. Last – %/in (25,4mm) [eccentric load sensitivity - %/in]	±0.1	±0.1	±0.1	±0.1
TEMPERATUR [temperature]				
kompensierter Temperaturbereich – °C [compensated temperature range - °C]	-10 bis [to] 45			
Arbeitstemperaturbereich – °C [operating temperature range - °C]	-55 bis [to] 90			
Nullsignaleinfluss TK ₀ – % RO/ K – MAX [effect on zero - %RO/K max]	±0.0015			
Kennwerteinfluss TK _C – %/ K – MAX [effect on output - %RO/K – max]	±0.0015			
ELEKTRISCH [electrical]				
Kennwert C _{nom} – mV/V (nominal) [rated output – mV/V (nom)]	1.0	2.0		
Versorgungsspannung – VDC MAX [excitation voltage – VDC max]	20			
Brückenwiderstand – Ohm (nominal) [bridge resistance – Ohm (nom)]	350			
Rel. Nullsignalabweichung d _{s,0} – % [zero balance - %RO]	±1.0			
Isolationswiderstand – MΩ [insulation resistance - MΩ]	5000			
MECHANISCH [mechanical]				
Grenzkraft FL – % [safe overload - %CAP]	±300			
Messweg s _{nom} – mm [deflection – mm]	0.013	0.025	0.025	0.050
Metrischer Sockel – Optional [metric base – option]	B101 (M)	B102 (M)	B103 (M)	B112 (M)
Eigenfrequenz f _G – kHz [natural frequency – kHz]	5.0, 6.9, 9.8	6.6, 9.4	6.5, 7.0	5.8
Gewicht – kg [weight – kg]	0.7	1.5	4.3	12
Gewicht mit Sockel – kg [weight with base – kg]	1.4	3	8.6	24
Material Messfeder [material spring element]	Aluminium	Legierter Stahl [alloy steel]		
Schutzart nach EN 60529 [degree of protection as per EN 60529]	IP64 (IP67 auf Anfrage) [IP64 (IP67 on request)]			
Kalibrierung [calibration]	Druck und Zug [tension & compression]			

PARAMETER	MODELL [model]					
	1040	1044	1052	1060	1080	1090
	Nennkraft F _{nom} [range]					
U.S. lbf	100k	135k	200k	300k	500k	1000k
Metrisch [metric] kN	450	600	900	1500	2250	4500
GENAUIGKEIT – MAX FEHLER [accuracy – max error]						
Fehlerbandbreite – % Nennkraft F _{nom} [static error - %FS]	±0.06	±0.07	±0.09	±0.10	±0.15	±0.20
Rel. Linearitätsabweichung d _{lin} –% [nonlinearity - %FS]	±0.06	±0.08	±0.09	±0.10	±0.15	±0.20
Rel. Umkehrspanne u _{0,4} –% Nennkraft F _{nom} [hysteresis - %FS]	±0.06	±0.08	±0.09	±0.10	±0.15	±0.20
Rel. Reproduzierbarkeit – % [non-repeatability - %RO]	±0.02	±0.02	±0.02	±0.02	±0.02	±0.02
Rel. Kriechen, in 20 min – % [creep, in 20 min - %]	±0.025	±0.025	±0.025	±0.025	±0.025	±0.025
Seitenlastempfindlichkeit – % [side load sensitivity - %]	±0.1	±0.25	±0.25	±0.25	±0.25	±0.25
Fehler bei exzentr. Last – %/in (25,4mm) [eccentric load sensitivity - %/in]	±0.1	±0.25	±0.25	±0.25	±0.25	±0.50
TEMPERATUR [temperature]						
kompensierter Temperaturbereich °C [compensated temperature range - °C]	-10 bis [to] 45					
Arbeitstemperaturbereich – °C [operating temperature range - °C]	-55 bis [to] 90					
Nullsignaleinfluss TK ₀ – % RO/ K – MAX [effect on zero - %RO/K max]	±0.0015					
Kennwerteinfluss TK _C –%/ K – MAX [effect on output - %RO/K – max]	±0.0015					
ELEKTRISCH [electrical]						
Kennwert C _{nom} – mV/V (nominal) [rated output – mV/V (nom)]	2.0					
Versorgungsspannung – VDC MAX [excitation voltage – VDC max]	20					
Brückenwiderstand – Ohm (nominal) [bridge resistance – Ohm (nom)]	350					
Rel. Nullsignalabweichung d _{s,0} – % [zero balance - %RO]	±1.0					
Isolationswiderstand – MΩ [insulation resistance - MΩ]	5000					
MECHANISCH [mechanical]						
Grenzkraft FL – % [safe overload - %CAP]	±300					
Messweg s _{nom} – mm [deflection – mm]	0.075	0.076	0.10	0.10	0.13	0.13
Metrischer Sockel – Optional [metric base – option]	B105 (M)	B116 (M)	B121 (M)	B122 (M)	B123 (M)	B125 (M)
Eigenfrequenz f _G – kHz [natural frequency – kHz]	4.9	5.0	5.5	5.5	5.5	5.5
Gewicht – kg [weight – kg]	30.9	31.8	45	90	205	390
Gewicht mit Sockel – kg [weight with base – kg]	61.8	63.6	90	180	410	780
Material Messfeder [material spring element]	Legierter Stahl [alloy steel]					
Schutzart nach EN 60529 [degree of protection as per EN 60529]	IP64 (IP67 auf Anfrage) [IP64 (IP67 on request)]					
Kalibrierung [calibration]	Druck und Zug [tension & compression]					

Abmessungen [Dimensions]



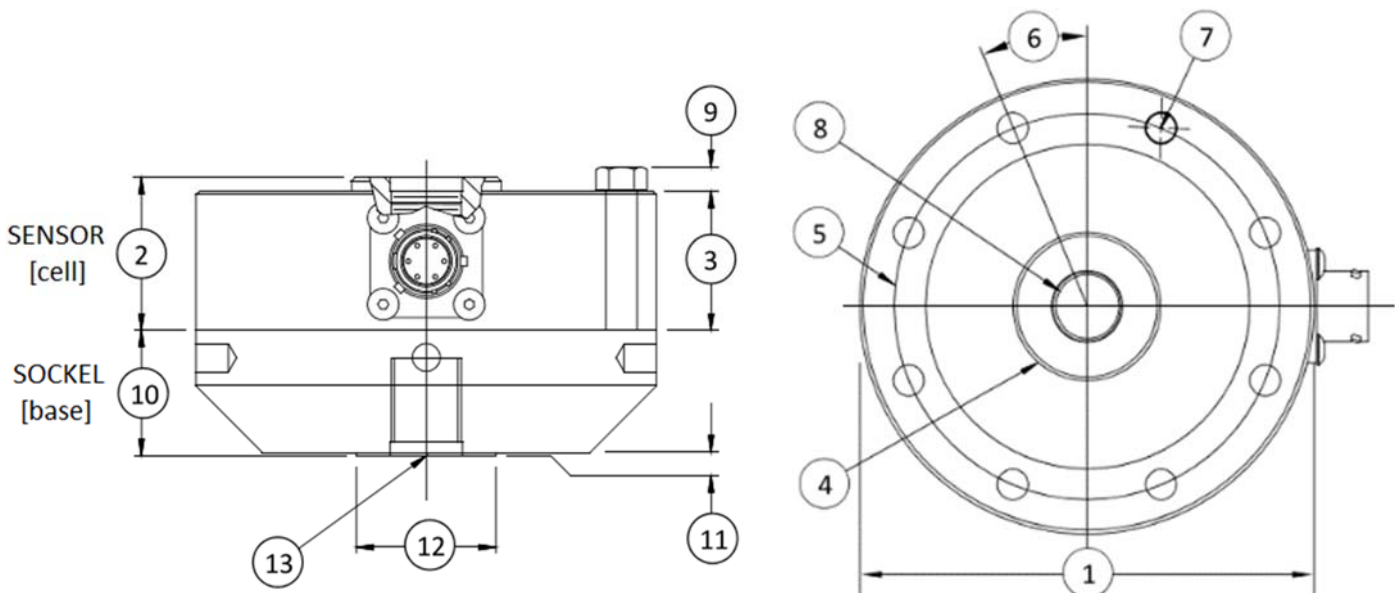

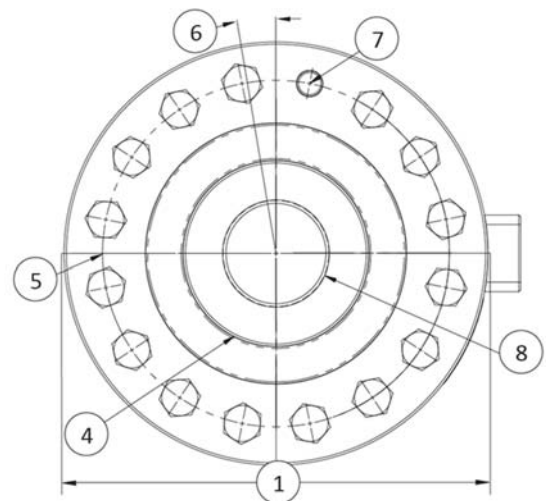
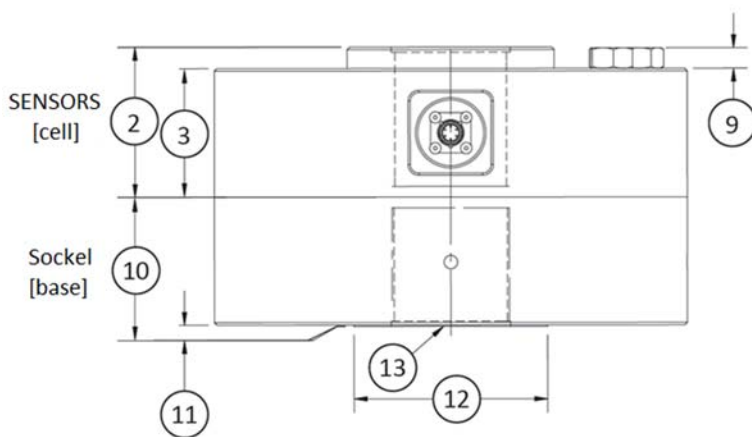

Siehe Zeichnung [see drawing]	MODELL [model]					
	1010		1020		1032	
	US (lbf)	Metrisch (kN) [metric]	US (lbf)	Metrisch (kN) [metric]	US (lbf)	Metrisch (kN) [metric]
	250, 500, 1k 2.5k, 5k	1.25, 2.5, 5 12.5, 25	12.5k, 25k	50, 125	50k	225
	inch	mm	inch	mm	inch	mm
(1)	4.13	104.8	6.06	153.9	8.00	203.2
(2)	1.38	34.9	1.75	44.5	2.50	63.5
(3)	1.25	31.7	1.63	41.4	2.25	57.2
(4)	1.34	34.0	2.65	67.3	3.76	95.2
(5)	3.50	88.9	5.13	130.3	6.50	165.1
(6)	22.5°	22.5°	15.0°	15.0°	11.25°	11.25°
(7)	0.28	7.10	0.41	10.4	0.53	13.5
	8 Löcher [holes]		12 Löcher [holes]		16 Löcher [holes]	
(8)	5/8-18 UNF-3B	M16x2-4H	1 1/4-12 UNF-3B	M33x2-4H	1 3/4-12 UNF-3B	M42x2-4H
	1.12 in tief [deep]	28.4 mm tief [deep]	1.40 in tief [deep]	35.6 mm tief [deep]	2.15 in tief [deep]	54.6 mm tief [deep]
(9)	0.20	5.10	0.30	7.60	0.40	10.2
(10)	1.13	28.6	1.75	44.5	2.00	50.8
(11)	0.03	0.80	0.03	0.80	0.03	0.80
(12)	1.25	31.8	2.25	57.2	3.00	76.2
(13)	5/8-18 UNF-3B	M16x2-4H	1 1/4-12 UNF-3B	M33x2-4H	1 3/4-12 UNF-3B	M42x2-4H
	.87 in tief [deep]	22.1 mm tief [deep]	1.40 in tief [deep]	35.6 mm tief [deep]	1.75 in tief [deep]	44.5 mm tief [deep]



Siehe Zeichnung [see drawing]	MODELL [model]											
	1040		1044		1052		1060		1080		1090	
	Nennkraft F_{nom} [range]											
	U.S.	Metrisch [metric]	U.S.	Metrisch [metric]	U.S.	Metrisch h [metric]	U.S.	Metrisch ch [metric]	U.S.	Metrisch [metric]	U.S.	Metrisch [metric]
	(lbf)	(kN)	(lbf)	(kN)	(lbf)	(kN)	(lbf)	(kN)	(lbf)	(kN)	(lbf)	(kN)
	100k	450	135k	600	200k	900	300k	1500	500k	2250	1000k	4500
inch	mm	inch	mm	inch	mm	inch	mm	inch	mm	inch	mm	
(1)	11.0	279.0	11.0	279.0	12.0	304.8	15.5	393.7	20.50	520.7	26.00	660.4
(2)	3.50	88.9	4.00	101.6	4.50	114.3	5.50	139.7	6.25	158.8	7.75	196.9
(3)	3.00	76.2	3.25	82.6	4.25	108.0	5.00	127.0	6.00	152.4	7.50	190.5
(4)	4.81	122.2	4.81	122.2	6.18	156.8	7.73	196.3	10.55	267.9	13.79	350.3
(5)	9.00	228.6	8.75	222.2	9.88	250.8	12.68	322.1	16.5	419.1	20.50	520.7
(6)	11.25°	11.25°	11.25°	11.25°	9.00°	9.00°	7.50°	7.50°	6.43°	6.43°	5.63°	5.63°
(7)	0.65	16.5	0.79	20.1	0.79	21.0	0.94	23.9	1.06	27.0	1.31	33.3
	16 Löcher [holes]		16 Löcher [holes]		20 Löcher [holes]		24 Löcher [holes]		28 Löcher [holes]		32 Löcher [holes]	
(8)	2 3/4-8 UNF-3B	M72 X 2-4H	2 3/4-8 UNF-3B	M72 X 2-4H	3 1/2-8 UN-3B	M90 X 3-4H	4 1/4-8 UN-3B	M120 X 4-4H	6.00-8 UN-3B	M150 X 4-4H	8.00-8 UN-3B	M200 X 4-4H
	3.25 in tief [deep]	82.6 mm tief [deep]	3.75 in tief [deep]	96.3 mm tief [deep]	3.75 in tief [deep]	95.2 mm tief [deep]	4.25 in tief [deep]	108 mm tief [deep]	5.63 in tief [deep]	130 mm tief [deep]	7.00 in tief [deep]	178 mm tief [deep]
(9)	0.50	12.7	0.50	12.7	0.58	12.5	0.69	17.5	1.00	25.4	1.25	31.3
(10)	3.00	76.2	4.00	101.6	4.50	114.3	5.00	127.0	7.00	177.8	9.00	228.6
(11)	0.03	0.80	0.03	0.80	0.03	0.80	0.03	0.80	0.03	0.80	0.10	2.5
(12)	4.50	114.3	4.50	114.3	6.00	152.4	7.75	196.9	10.55	267.9	14.00	355.6
(13)	2 3/4-8 UNF-3B	M72 X 2-4H	2 3/4-8 UNF-3B	M72 X 2-4H	3 1/2-8 UN-3B	M90 X 3-4H	4 1/4-8 UN-3B	M120 X 4-4H	6.00-8 UN-3B	M150 X 4-4H	8.00-8 UN-3B	M200 X 4-4H
	2.75 in tief [deep]	69.8 mm tief [deep]	3.75 in tief [deep]	95.3 mm tief [deep]	3.75 in tief [deep]	95.2 mm tief [deep]	4.25 in tief [deep]	108 mm tief [deep]	6.38 in tief [deep]	162 mm tief [deep]	7.25 in tief [deep]	184 mm tief [deep]

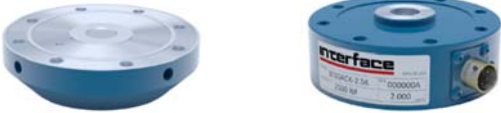

Verfügbare Varianten [available versions]

<p>Modell [model]: 1010ACK-2,5K-B Sensor mit Bajonett-Stecker und optionalem Sockel [sensor with bayonet connector and optional base]</p> 	<p>Modell [model]: 1010AJ-2,5K-B Sensor mit 3m Kabelanschluss und optionalem Sockel [sensor with 3m cable connection and optional base]</p> 
<p>Modell [model]: 1010AF-2,5K-B Sensor mit Schraub-Stecker und optionalem Sockel [sensor with screw-type connector and optional base]</p> 	<p>Modell [model]: 1010ACK-2,5K Sensor mit Bajonett-Stecker (ohne montierten Sockel) [sensor with bayonet connector (without mounted base)]</p> 
<p>Modell [model]: 1040CDS-100K-B Sensor mit Bajonett-Stecker, optionalem Sockel und Steckerschutz [sensor with bayonet connector, optional base and connector protection]</p> 	<p>Modell [model]: 1040ALD-100K-B Sensor mit Schraub-Stecker, optionalem Sockel und Steckerschutz [sensor with screw-type connector, optional base and connector protection]</p> 
<p>Modell [model]: 1040CDS-100K Sensor mit Bajonett-Stecker und Steckerschutz, ohne optionalem Sockel [sensor with bayonet connector and connector protection, without optional base]</p> 	<p>Modell [model]: 1040CDS-100K Sensor mit Bayonett-Stecker und Steckerschutz (ohne montierten Sockel) [sensor with bayonet connector and connector protection (without mounted base)]</p> 

Verfügbare Optionen und Zubehör [available options & accessories]

- Sockel - empfohlen [base – recommended]
- Edelstahlversionen [stainless steel versions]
- Sondergewinde a.A. [special threads on request]
- Vakuum Versionen a.A. [vacuum rated versions on request]
- Robuster Steckerschutz [heavy duty connector protection] – Standard ab 450kN [standard feature from 450kN]
- Normiertes Ausgangssignal [standardized output] +/-0,1%
- TEDS – Transducer Electronic Data Sheet
- Mehrfach-Messbrücken oder Biegemoment-Messbrücken zur Überwachung [multiple bridge or moment bridges for monitoring]
- Kundenspezifische Kabellängen [customized cable length]
- Zusätzlicher Druck-Drucküberlastschutz (nur mit Sockel mgl.) [additional compression overload protection (available only with base)]
- Kundenspezifische (erweiterte) Temperaturkompensation [customized (extended) compensated temperature range]
- Messverstärker und Anzeigen [amplifier & displays]
- Mechanische Adapter [mechanical adaptors]
- Gegenstecker – auf Wunsch mit Anschlusskabel [mating connector – also with cable available]
- Sonderlackierung (Farbe oder z.B. Skydrol-Schutz) [special painting or Skydrol protection]
- Kundenspezifische Typenschilder auf Sensor und Zertifikat [custom labeling on sensor and certification]

Zubehör [accessories]

 <p>Kalibrieradapter [calibration adaptors]</p>	 <p>Gabelköpfe [clevises]</p>	 <p>Kontermutter [jam nut]</p>
 <p>Gewindeadapter [thread adaptors]</p>	 <p>Montageplatten [mounting plates]</p>	 <p>Druckknöpfe [load buttons]</p>
 <p>Gelenkaugen [rod end bearings]</p>	 <p>TEDS Transducer Electronic Data-Sheet</p>	 <p>Shunt Widerstand [shunt resistors]</p>
 <p>Gegenstecker [mating connectors]</p>	 <p>Steckerschutz [connector protection]</p>	 <p>Anschlusskabel und Kabelkonfektionierung [cable & cable assembly]</p>
 <p>Mehrfach-Messbrücken [multiple bridges]</p>	 <p>Klemmbox [terminal box]</p>	 <p>Anzeigen und Datenlogger [displays and data logger]</p>
 <p>Messverstärker [amplifier]</p>	 <p>Eingebaute Messverstärker [build-in amplifier]</p>	 <p>Wireless & Bluetooth</p>