

Serie 1201 Flachprofil- Nur-Druckkraftaufnehmer [Low-Profile® Compression Load Cell]

- Nur Druck-Kräfte
[compression only force]
- Messbereiche von 5 kN bis 1800 kN (>1,8MN a.A.)
[ranges from 5 kN to 1800 kN (>1,8MN on request)]
- Sehr hohe Genauigkeiten
[very high accuracy]
- Kompensation der exzentrischen Kräfte
[eccentric load compensated]



Abmessungen [Dimensions]



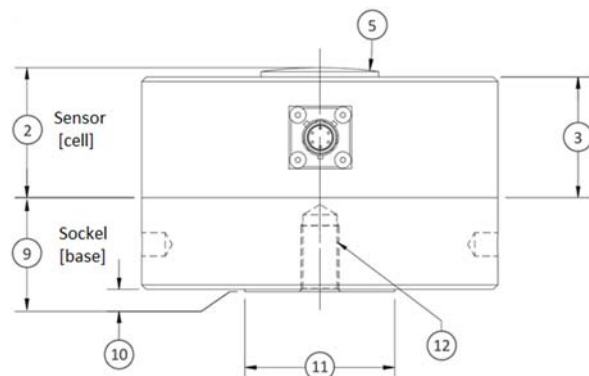
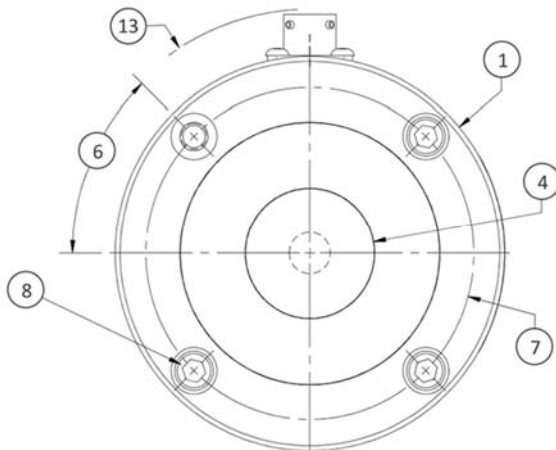



Siehe Zeichnung [see drawing] 3D Modelle verfügbar [ask for STEP model]	MODELL [model]									
	1211		1221		1231		1241		1243	
	Nennkraft F _{nom} [range]									
	Metrisch [metric] (kN)	U.S. (lbf)	Metrisch [metric] (kN)	U.S. (lbf)	Metrisch [metric] (kN)	U.S. (lbf)	Metrisch [metric] (kN)	U.S. (lbf)	Metrisch [metric] (kN)	U.S. (lbf)
5, 10, 25, 50	1k, 2k, 5k, 10k	125, 250	25k, 50k	450	100k	900	200k	1350, 1800	300k, 400k	
mm	inch	mm	inch	mm	inch	mm	inch	mm	inch	
(1)	Ø104.8	Ø4.13	Ø120.7	Ø4.75	Ø190.5	Ø7.50	Ø210.0	Ø8.25	Ø279.0	Ø11.00
(2)	34.9	1.38	44.5	1.75	57.2	2.25	82.5	3.25	88.9	3.50
(3)	31.7	1.25	41.4	1.63	50.8	2.00	76.2	3.00	76.2	3.00
(4)	Ø34.0	Ø1.34	Ø39.9	Ø1.57	Ø79.5	Ø3.13	Ø80.3	Ø3.16	Ø122.2	Ø4.81
(5)	SR 152.4	SR 6.00	SR 152.4	SR 6.00	SR 203.2	SR 8.00	SR 304.8	SR 12.00	SR 457.0	SR 18.00
(6)	22.5°		45°		15.0°		15.0°		11.25°	
(7)	Ø88.9	Ø3.50	Ø101.6	Ø4.00	Ø158.8	Ø6.25	Ø171.5	Ø6.75	Ø229.0	Ø9.00
(8)	8x ¼-28 x 1.25		4x 5/16-24 x 1.75		12x 7/16-20 x 2		12x 5/8-18 x 3		16x 5/8-18 x 3	
(9)	28.7	1.13	31.8	1.25	50.8	2.00	63.5	2.50	88.9	3.50
(10)	0.8	0.03	0.8	0.03	0.8	0.03	0.8	0.03	0.8	0.03
(11)	Ø31.8	Ø1.25	Ø50.8	Ø2.00	Ø76.2	Ø3.00	Ø76.2	Ø3.00	Ø114.0	Ø4.50
(12)	M16x2- 4H ↓ 22.1	¾-18 UNF-3B ↓ 0.87	M16x2-6H ↓ 22.4	½-20 UNF-3B ↓ 0.88	M27x2-6H ↓ 44.5	1¼-12 UNF-3B ↓ 1.75	M27x2- 6H ↓ 38.1	¾-16 UNF-3B ↓ 1.50	M42x2-6H ↓ 50.8	1½-12 UNF-3B ↓ 2.00
(13)	64.0	2.52	76.2	3.00	110.2	4.34	119.6	4.71	163.6	6.44

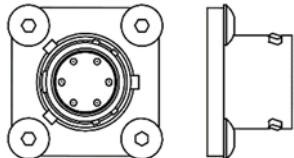

Technische Daten [technical data]

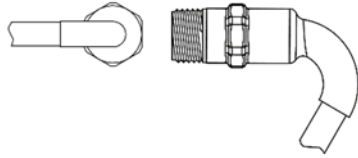
PARAMETER	MODELL [model]					
	1211	1211	1221	1231	1241	1243
	Nennkraft F _{nom} [range]					
U.S. lbf	1k, 2k	5k, 10k	25k, 50k	100k	200k	300k, 400k
Metrisch [metric] kN	5, 10	25, 50	125, 250	450	900	1350, 1800
GENAUIGKEIT – MAX FEHLER [accuracy – max error]						
Fehlerbandbreite – % Nennkraft F _{nom} [static error - %FS]	±0.03	±0.04	±0.04	±0.04	±0.05	±0.05
Rel. Linearitätsabweichung d _{lin} –% [nonlinearity - %FS]	±0.03	±0.04	±0.05	±0.05	±0.05	±0.05
Rel. Umkehrspanne u _{0,4} –% Nennkraft F _{nom} [hysteresis - %FS]	±0.03	±0.04	±0.05	±0.05	±0.05	±0.05
Rel. Reproduzierbarkeit – % [non-repeatability - %RO]	±0.01	±0.01	±0.01	±0.01	±0.01	±0.01
Rel. Kriechen, in 20 min – % [creep, in 20 min - %]	±0.025	±0.025	±0.025	±0.025	±0.025	±0.025
Seitenlastempfindlichkeit – % [side load sensitivity - %]	±0.25	±0.25	±0.25	±0.25	±0.25	±0.25
Fehler bei exzentr. Last – %/in (25,4mm) [eccentric load sensitivity - %/in]	±0.25	±0.25	±0.25	±0.25	±0.25	±0.25
TEMPERATUR [temperature]						
kompensierter Temperaturbereich °C [compensated temperature range - °C]	-10 bis [to] 45					
Arbeitstemperaturbereich – °C [operating temperature range - °C]	-55 bis [to] 90					
Nullsignaleinfluss TK ₀ – % RO/ K – MAX [effect on zero - %RO/K max]	±0.0015					
Kennwerteinfluss TK _C –%/ K – MAX [effect on output - %RO/K – max]	±0.0015					
ELEKTRISCH [electrical]						
Kennwert C _{nom} – mV/V (nominal) [rated output – mV/V (nom)]	2.0	4.0				3.0 – 1350kN 4.0 – 1800kN
Versorgungsspannung – VDC MAX [excitation voltage – VDC max]	20					
Brückenwiderstand – Ohm (nominal) [bridge resistance – Ohm (nom)]	350					
Rel. Nullsignalabweichung d _{s,0} – % [zero balance - %RO]	±1.0					
Isolationswiderstand – MΩ [insulation resistance - MΩ]	5000					
MECHANISCH [mechanical]						
Grenzkraft FL – % [safe overload - %CAP]	±150					
Messweg s _{nom} – mm [deflection – mm]	0.025	0.051	0.051	0.076	0.102	0.127
Metrischer Sockel – Optional [metric base – option]	B101 (M)	B102 (M)	B106 (M)	B104 (M)	B108 (M)	B124 (M)
Eigenfrequenz f ₀ – kHz [natural frequency – kHz]	6.4, 9.0	6.1, 8.6	8.2, 11.7	7.6	6.7	5.0
Gewicht – kg [weight – kg]	0.7	1.5	3.1	6	18	34
Gewicht mit Sockel – kg [weight with base – kg]	1.4	3	6.2	12	36	68
Material Messfeder [material spring element]	Aluminium	Legierter Stahl [alloy steel]				
Schutzart nach EN 60529 [degree of protection as per EN 60529]	IP64 (IP67 auf Anfrage) [IP64 (IP67 on request)]					
Kalibrierung [calibration]	Druck [compression]					

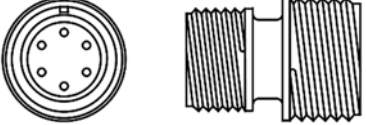
Verfügbare Varianten [available versions]

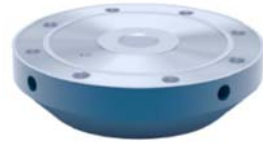
<p>Modell [model]: 1221BAY-50K Sensor mit Bajonett-Stecker (ohne Sockel) [sensor with bayonet connector (without base)]</p>  	<p>Modell [model]: 1221EX-50K Sensor mit 3m Kabelanschluss (ohne Sockel) [sensor with 3m cable connection and optional base]</p>  
<p>Modell [model]: 1221HL-50K Sensor mit Schraub-Stecker ohne Sockel [sensor with screw-type connector (without base)]</p>  	<p>Modell [model]: 1221BAY-50K Sensor mit Bajonett-Stecker (ohne montierten Sockel) [sensor with bayonet connector (without mounted base)]</p>  <p>Sockel (optional)</p> 

Verfügbare Optionen und Zubehör [available options & accessories]

- Sockel - empfohlen [base – recommended]
- Edelstahlversionen [stainless steel versions]
- Sondergewinde a.A. [special threads on request]
- Vakuum Versionen a.A. [vacuum rated versions on request]
- Robuster Steckerschutz [heavy duty connector protection] – Standard ab 450kN [standard feature from 450kN]
- Normiertes Ausgangssignal [standardized output] +/-0,1%
- TEDS – Transducer Electronic Data Sheet
- Mehrfach-Messbrücken oder Biegemoment-Messbrücken zur Überwachung [multiple bridge or moment bridges for monitoring]
- Kundenspezifische Kabellängen [customized cable length]
- Zusätzlicher Druck-Drucküberlastschutz (nur mit Sockel mgl.) [additional compression overload protection (available only with base)]
- Kundenspezifische (erweiterte) Temperaturkompensation [customized (extended) compensated temperature range]
- Messverstärker und Anzeigen [amplifier & displays]
- Mechanische Adapter [mechanical adaptors]
- Gegenstecker – auf Wunsch mit Anschlusskabel [mating connector – also with cable available]
- Sonderlackierung (Farbe oder z.B. Skydrol-Schutz) [special painting or Skydrol protection]
- Kundenspezifische Typenschilder auf Sensor und Zertifikat [custom labeling on sensor and certification]
- ISO-376 oder ASTE74 Kalibrierung a.A. [ISO-376 or ASTM E74 calibration on request]

Zubehör [accessories]

 <p>Kalibrieradapter [calibration adaptors]</p>	 <p>Gabelköpfe [clevises]</p>	 <p>Kontermutter [jam nut]</p>
 <p>Gewindeadapter [thread adaptors]</p>	 <p>Montageplatten [mounting plates]</p>	 <p>Druckknöpfe [load buttons]</p>
 <p>Gelenkaugen [rod end bearings]</p>	 <p>TEDS Transducer Electronic Data-Sheet</p>	 <p>Shunt Widerstand [shunt resistors]</p>
 <p>Gegenstecker [mating connectors]</p>	 <p>Steckerschutz [connector protection]</p>	 <p>Anschlusskabel und Kabelkonfektionierung [cable & cable assembly]</p>
 <p>Mehrfach-Messbrücken [multiple bridges]</p>	 <p>Klemmbox [terminal box]</p>	 <p>Anzeigen und Datenlogger [displays and data logger]</p>
 <p>Messverstärker [amplifier]</p>	 <p>Eingebaute Messverstärker [build-in amplifier]</p>	 <p>Wireless & Bluetooth</p>